

č. sch. 2



č. sch. 3



č. sch. 4

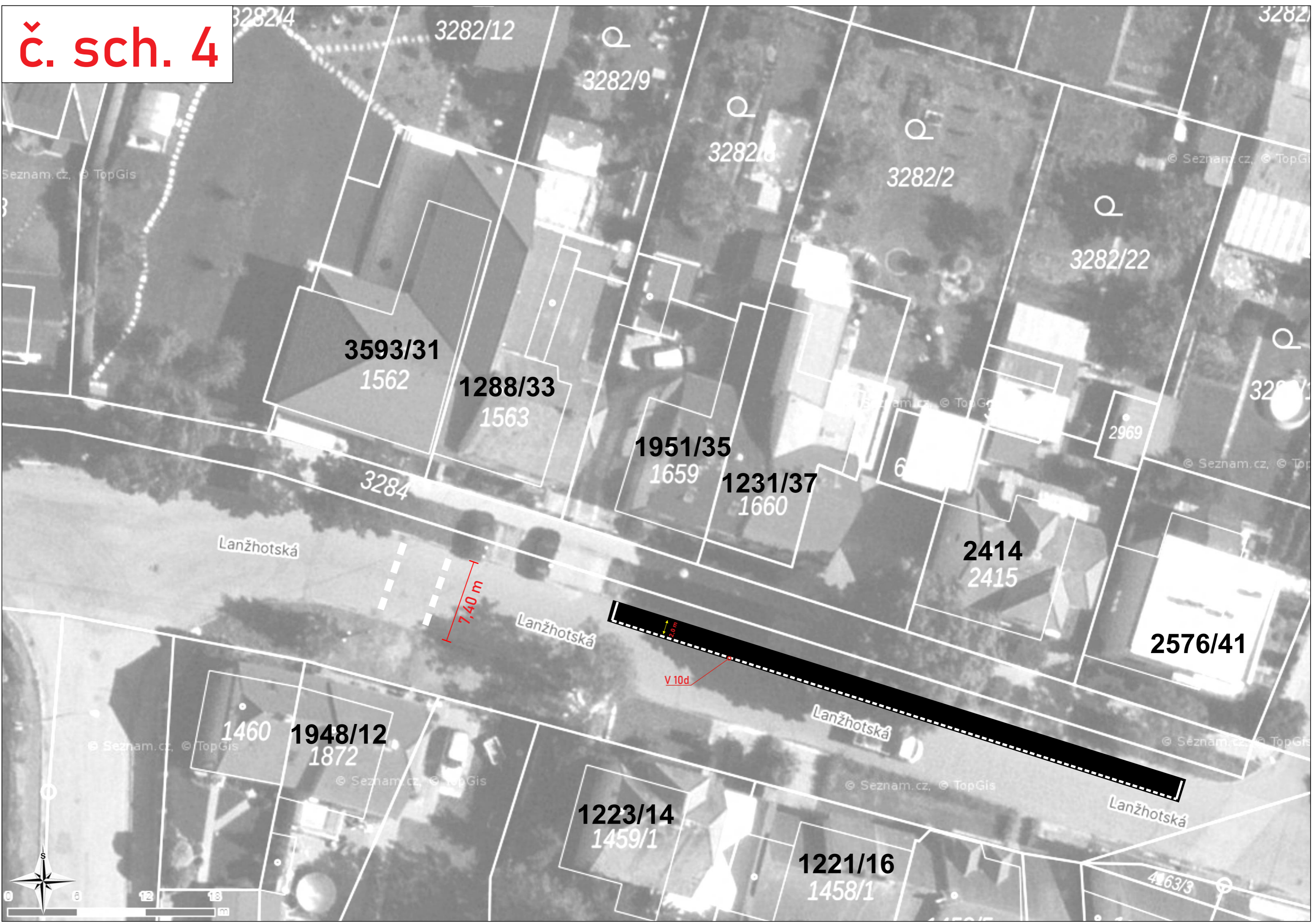

č. sch. 5



č. sch. 6



č. sch. 7

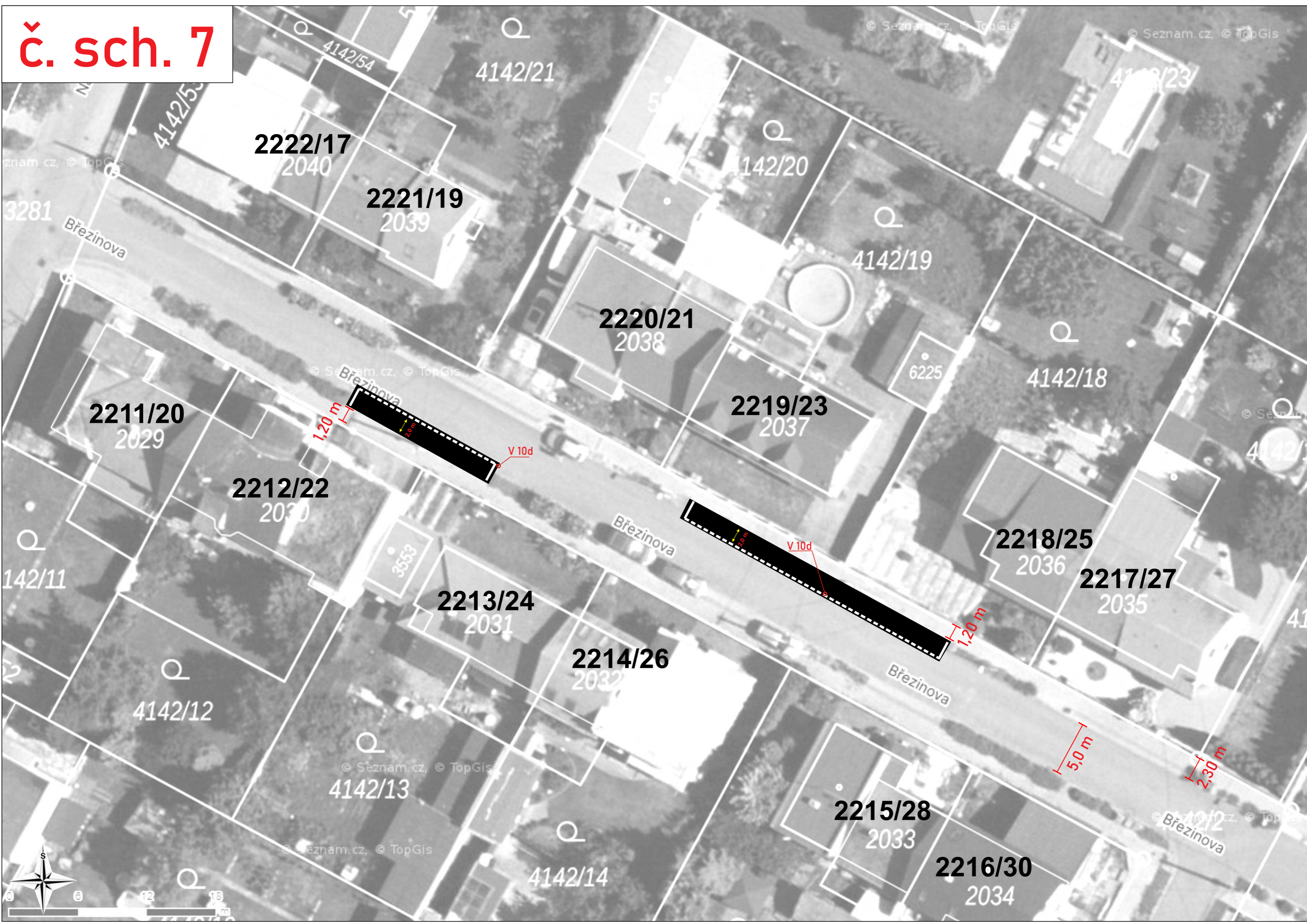

č. sch. 8

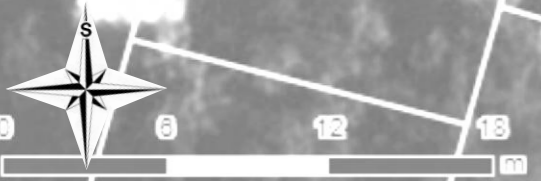
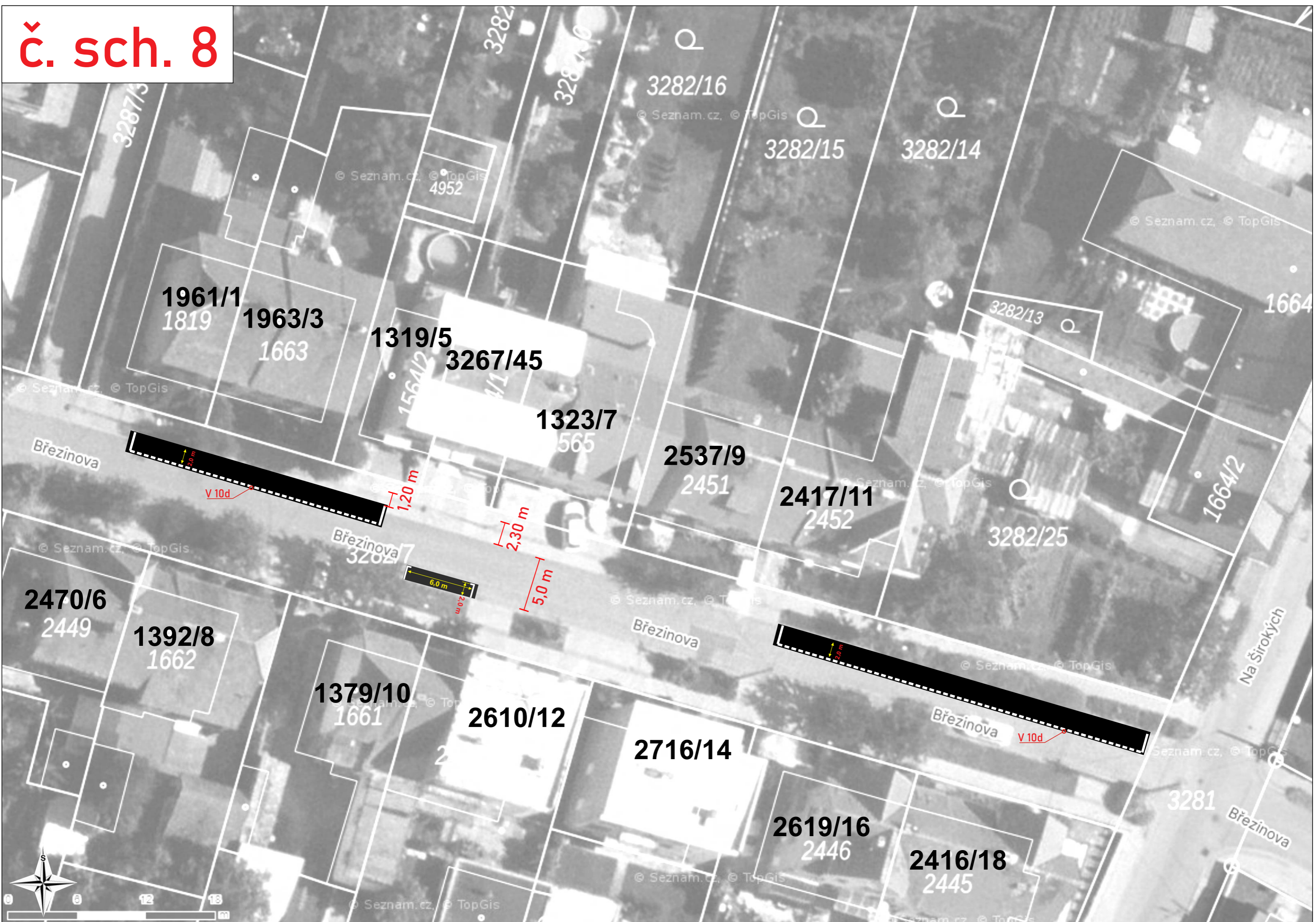

č. sch. 9



č. sch. 10



č. sch. 11

Břeclav, ul. Lanžhotská, Březinova, Na Širokých - místní komunikace
vodorovné dopravní značení

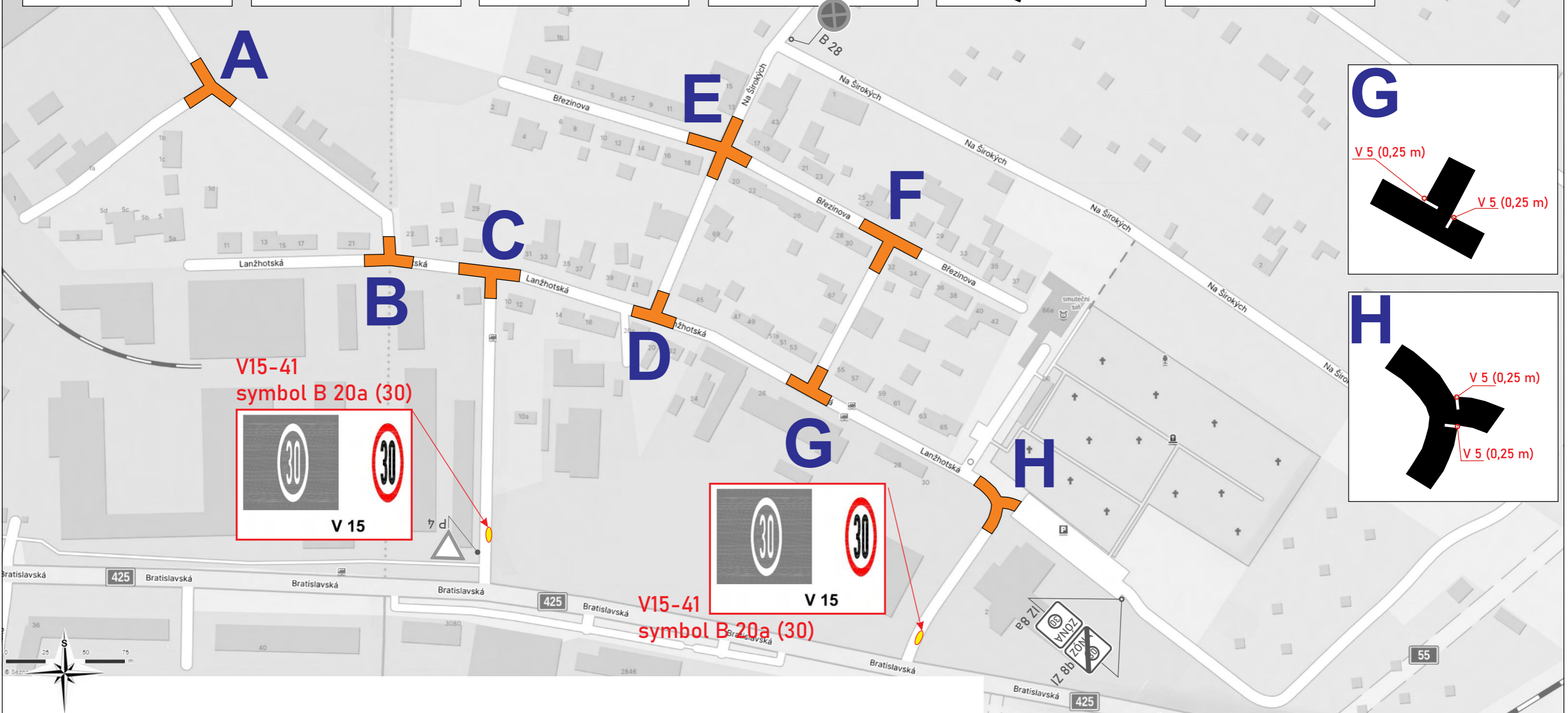
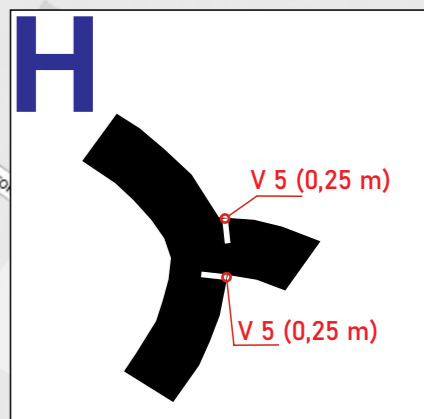
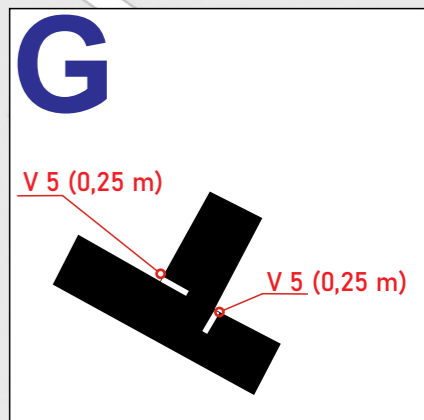
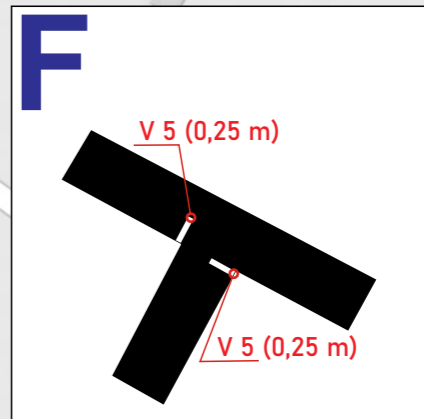
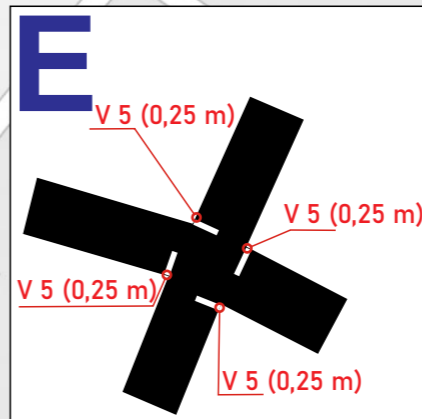
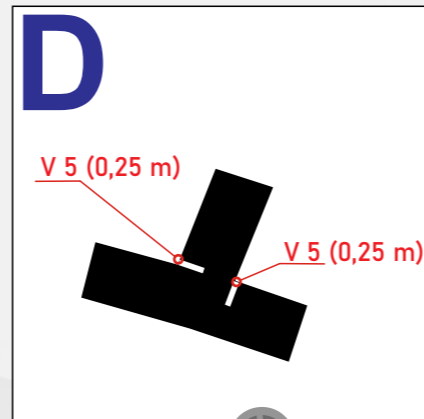
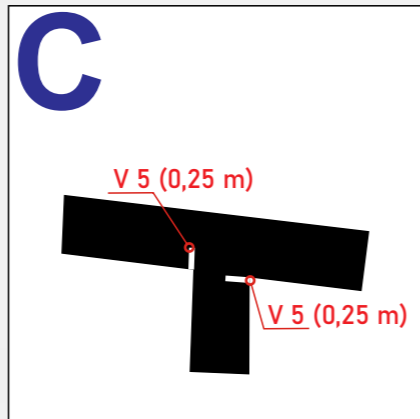
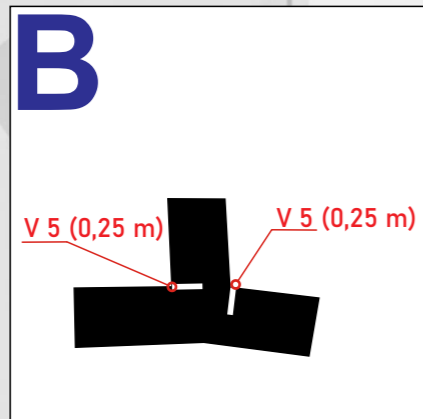
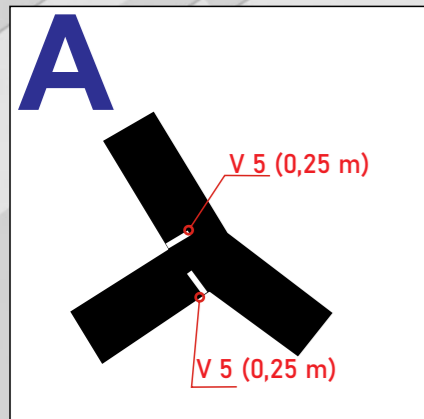

V15-41
symbol B 20a (30)

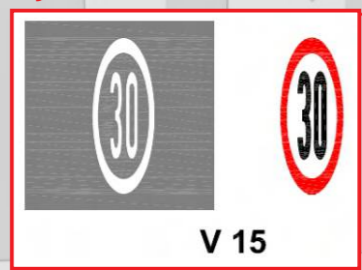

V15-41
symbol B 20a (30)

